



CROWN RUBBER WORKS
Total sealing solutions
W-10 T.C. INDUSTRIAL AREA PANDHURJIC HAVY NUBRAH - 481705

CROWN RUBBER WORKS

TOTAL SEALING SOLUTIONS



Since **1995**, CROWN RUBBER WORKS is at the forefront of delivering excellence as a dominant manufacturer, exporter, supplier, trader and importer firm developing world class Seals and Rubber Products.

We compete in the **international market** with a wide gamut of quality approved products including Hydraulic Seals, Seal kits, and Oil seals. The secret behind our strong international presence is the comprehensive line of features of our developed products that are highly acclaimed for better housing retention, superior resistance to thermal expansion, metal encased strength seal, dust resistant fitting, leak proof performance and precise dimensions.

In order to meet the business needs of our valued patronage from across the globe, we strive to adapt new technologies and new business policies. Our proficient team improvises the business strategies to harmonize our production operations with the exacting requirements of our clients. We have implemented leading technology at our infrastructure which includes CNC seal manufacturing machines. Moreover, our products are distributed with the brand name Crown. And, we also source finest range of products from **Austria, Taiwan, Turkey, Italy** and **Singapore** to garner the business needs. Our clients from across the nation, including exporting countries of **Gulf Singapore** and **Sri Lanka** find our products reliable and most equitable.

Under the valuable guidance of **Mr. Anis Ansari**, we are able to focus on the high tech manufacturing operations and market functions to distribute our line of products into diverse geographies. He motivates us to create a stronger presence in the industry by anticipating the client needs.





We have an in-depth understanding of various industries that help us to develop innovative products for our clients. We are better equipped, than others, to offer the best rubber products like automotive rubber products, automotive rubber components that are used in different applications of diverse industries.

Our end customers are spread over the following range of industries:

• **Earthmoving Ind.**

• **Hydraulic Ind.**

• **Construction Ind.**

• **Steel Plants**

• **Cement Plant**

• **Power Plants**

• **Mining Ind.**

• **Oil & Gas Ind.**

• **Ship Building & Railway**

• **Agriculture Ind.**

• **Food & Beverages**

• **Pharmaceutical Ind.**



Quality has always been our prime forte of excellence and as a company we have always laid a lot of emphasis on the same. The entire production procedure is the result of stringent quality measures that are adopted by us.

We have a team of quality managers who keep a strict and close eye on the entire production procedure right from the selection of the raw materials to the final dispatch.

We have established systems and business processes that increase our productivity and make us able to garner to the exacting requirements. To achieve the goal, we push boundaries and technologies to adapt a stringent quality policy.

Our quality control associates make sure that only best suited inventory of raw material is being utilized in the production. Moreover, we confirm that every product undergoes strict quality inspections before shipment to assure its worth.

COMPANY CERTIFICATIONS

The success of the company all these years has been marked by constant Research and Development and adherence to the stringent quality requirements of the Indian Standards. Focus of the company on quality and research and development is so high that the promoter, personally visits various countries and various customers regularly to assess the effectiveness of the R & D and Quality. At R & D centers, we are capable of developing special compound ideally fit for industrial demands. With in-house rubber compounding facilities, Crown Rubber Works support customers with not only competitive price, but also with varieties of raw materials suitable for all applications.



CUSTOMISED MACHINED SEALS



THE ONE HOUR SEAL FACTORY

Advanced technology custom made machined seals system
Exact sealing solutions with high quality raw material
Up to 1500 mm. outside diameter machined seals
More than 125 instant profiles and unlimited new types
Flexible process without tool cost and minimum order requirement
Quick solution for repair and maintenance



MEANDER SPRING

The Meander Spring, also referred to as a cantilever spring, is available in U-Spring or V-Spring profiles. It is supplied in industry standard 000 - 500 series including weld-free micro springs.



Style	Coil
Material	Stainless Steel

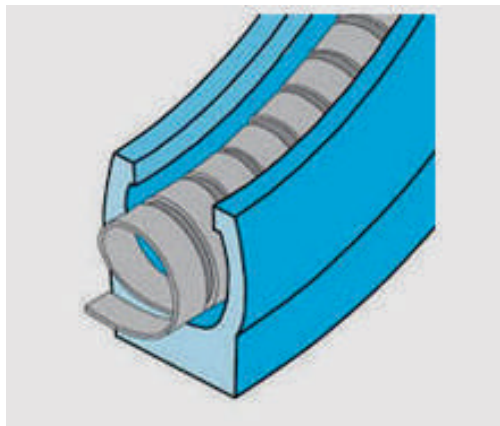

HELICAL SPRING

With the valuable assistance of skilled team of professionals, we are engaged in offering an extensive range of high-quality **Helical Spring**.

Style	Helical
Material	Stainless Steel
Packaging	Box

LARGE DIAMETER SEAL

We are capable to make machined seal up to 1500mm dia in PU, NBR or Teflon in quickest possible time without any tool. This is our express seal division.



TBM SEALS

We manufacture and developed large diameter seals up to 7500mm and other PU seals & seal kits for TBM (Tunnel Boring machine)



SEAL KITS

we provide components which are directly interchangeable with the original equipment manufacturers components. We do not imply that the components are the product of any original equipment manufacturers



Packaging Type	Packet
Material	Rubber
Style	Hydraulic

TYPES OF SEAL KITS

ROCK BREAKER SEAL KITS

Rock Breaker Seal Kit that we offer is made by using supreme quality raw material that adds durability to the product. We are an experienced name, which is engaged in manufacturing and supplying Rock Breaker Seal Kit.



Application	Construction Equipment, Hammer, Breaker, Excavator
Material	Rubber
Packaging Type	Plastic Bag
Temperature	Minus 25 to 200 Degree Celsius

PUMP SEAL KITS

Highly durable and efficiently working Pump Seal Kit is offer by us to customers. The offer Pump Seal Kit is extensively used in excavators like BEML/KOMATSU /L&T/ CATERPILLAR/TATA

Model No	All Models
Brand	AZS
Pack Type	Standard
Material	Nylon Rubber, Plastic, Polyurethane
Size	As Per SPEC

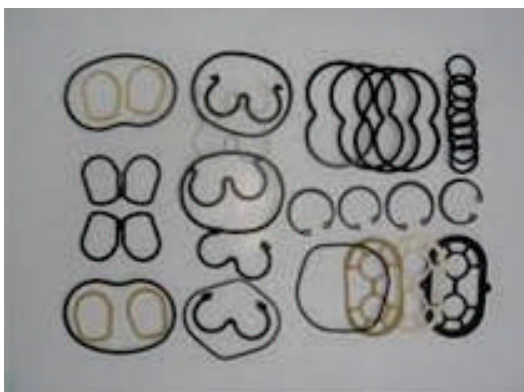

HYDRAULIC SEAL

PISTON SEALS

Piston Seals that we offer is manufactured using excellent quality material that has stable and low contact resistance, good mechanical strength and high hardness so that it is widely applicable to various electrical appliances.





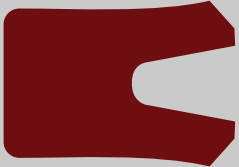
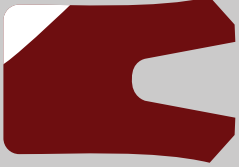
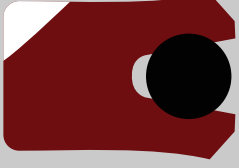
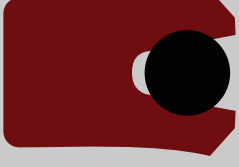

Size	60 x 80 mm
Material	Rubber
Brand	SSD
Shape	Circular
Product Type	Piston Seal



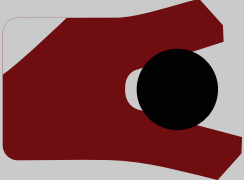

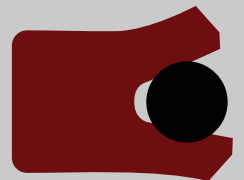
TYPES OF PISTON SEALS

Type	Product	Standard Material	Pressure (bar)	Temp. (°C)	Surface speed (m/sec)	Application
Ck1		PU	400	-30 to 100	0,5	Hydraulic
		NBR	160	-25 to 100		
		FPM	160	-20 to 210		
Ck2		PU / POM	700	-30 to 100	0,5	Hydraulic
		NBR / POM	250	-25 to 100		
		FPM / PTFE	250	-20 to 210		
Ck2-P		PU / POM	700	-30 to 100	0,5	Hydraulic
		NBR / POM	250	-25 to 100		
		FPM / PTFE	250	-20 to 210		
Ck3		PU	400	-25 to 100	0,5	Hydraulic
		NBR				



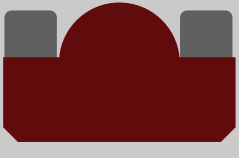
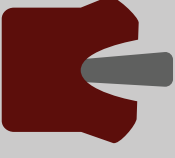

TYPES OF PISTON SEALS

Type	Product	Standard Material	Pressure (bar)	Temp. (°C)	Surface speed (m/sec)	Application
Ck4		PU	700	-25 to 100	0,5	Hydraulic
		NBR				
		POM				
Ck5		PU	25	-30 to 105	1	Hydraulic Pneumatic
		NBR		-25 to 100		
Ck6		PU	160	-30 to 105	0,5	Hydraulic Pneumatic
		NBR	160	-25 to 100		
		FPM	160	-20 to 210		
Ck7		PU	400	-25 to 100	0,5	Hydraulic
		NBR				
Ck8		PU / NBR	250	-25 to 100	1	Hydraulic
		PTFE / NBR	400		15	
Ck9		PU	400	-25 to 100	0,5	Hydraulic
		NBR				
		POM				



TYPES OF PISTON SEALS

Type	Product	Standard Material	Pressure (bar)	Temp. (°C)	Surface speed (m/sec)	Application
Ck 10-12		PU / POM	500	-30 to 100	0,5	Hydraulic
		NBR / POM	250	-25 to 100		
Ck 13-15		PU / POM	500	-30 to 105	0,5	Hydraulic
		NBR / POM	250	-25 to 100		
Ck16		PU	160	-25 to 100	0,5	Hydraulic Pneumatic
		NBR				
Ck17		PU / POM	400	-25 to 100	0,5	Hydraulic
		NBR / POM	250			
Ck20		NBR / POM	700	-25 to 100	0,5	Hydraulic
Ck22		PU / POM	400	-30 to 100	0,5	Hydraulic
		NBR / POM	160	-25 to 100		
		FPM / PTFE	160	-20 to 100		

TYPES OF PISTON SEALS

Type	Product	Standard Material	Pressure (bar)	Temp. (°C)	Surface speed (m/sec)	Application
Ck23		PU	400	-25 to 100	0,5	Hydraulic
		NBR				
		POM				
Ck25		NBR	300	-30°c + 110°c	0,5 m/s	Hydraulic
		POM				
Ck26		NBR + Febric	400	-30°c + 110°c	0,5 m/s	Hydraulic
		POM				
Ck27		NBR + Febric	700	-30°c + 110°c	0,5 m/s	Hydraulic
		POM				
Ck28		PTFE	700	-30°c + 110°c	0,5 m/s	Hydraulic
		NBR / PU				
		POM				
Ck30		NBR + FEBRIC FPM + FEBRIC	400	-30°c + 120°c	0,5 m/s	Hydraulic

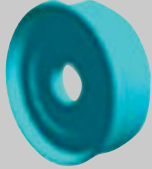
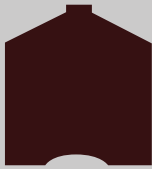
TYPES OF PISTON SEALS

Type	Product	Standard Material	Pressure (bar)	Temp. (°C)	Surface speed (m/sec)	Application
Ck33		NBR + METAL FPM + METAL	120	-30°C + 100°C	1 m/s	Pneumatic
Ck35		PU	300	-25°C + 110°C	-	Hydraulic
		NBR				
Ck36		PTFE	450	-45... 120	1	Hydraulic
		NBR + PU				
		POM				
Ck37		PTFE	450	-35... 100	1	Hydraulic
		NBR / PU				
		POM				







ROD SEALS





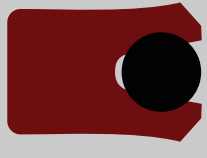

We are trusted name in manufacturing **Rod Seals** made from Nitrile, Neoprene, Viton and Polyurethane, These rod seals are the ones found in the hydraulic cylinder.

Size	10 mm to 1000 mm OD
Material	PU, NBR Viton
Brand	OMM
Color	Yellow, Blue, Orange & many more

TYPES OF ROD SEALS

Type	Product	Standard Material	Pressure (bar)	Temp. (°C)	Surface speed (m/sec)	Application
CS1		PU	400	-30 to 105	0,5	Hydraulic Pneumatic
		NBR	160	-25 to 100		
		FPM	160	-20 to 210		
CS2		PU / POM	700	-30 to 105	0,5	Hydraulic
		NBR / POM	250	-25 to 100		
		FPM / PTFE	250	-20 to 210		
CS2-P		PU / POM	700	-30 to 105	0,5	Hydraulic
		NBR / POM	250	-25 to 100		
		FPM / PTFE	250	-20 to 210		
CS3		PU / NBR	400	-25 to 100	0,5	Hydraulic
CS5		PU	25	-30 to 100	1	Hydraulic
		NBR		-25 to 100		
CS6		PU	160	-30 to 105	4	Hydraulic Pneumatic
		NBR	160	-25 to 100		
		FPM	160	-20 to 210		



TYPES OF ROD SEALS

Type	Product	Standard Material	Pressure (bar)	Temp. (°C)	Surface speed (m/sec)	Application
CS8		PU	400	-30 to 105	4	Hydraulic
		NBR	160	-25 to 100		
CS9		PU / NBR	250	-25 to 100	1	Hydraulic
		PTFE / NBR	400		10	
CS 10-12		PU / POM	500	-25 to 100	0,5	Hydraulic
		NBR / POM	250	-30 to 100		
CS16		NBR	160	-25 to 100	0,5	Hydraulic
CS17		PU	400	-30 to 105	1	Hydraulic
CS 17-P		PU / POM	700	-30 to 100	0,5	Hydraulic

TYPES OF ROD SEALS

Type	Product	Standard Material	Pressure (bar)	Temp. (°C)	Surface speed (m/sec)	Application
Cs20		NBR / POM	700	-25 to 100	0,5	Hydraulic
CS 25-27		PU / POM	500	-30 to 100	0,5	Hydraulic
		NBR / POM	200	-25 to 100		
Cs28		NBR / FEBRIC	400	-25 to 100	0,2	Hydraulic
		FPM / FEBRIC		-25 to 250		
CS29		NBR / FEBRIC	400	-25 to 100	0,5	Hydraulic
		FPM / FEBRIC		-25 to 250		
CS30		NBR / FEBRIC	400 / 600	-30°c + 120°c	0,5 m/s	Hydraulic
		FPM / FEBRIC				
CS32		PU / PTFE	450 / 300	-30°c + 100°c	1	Hydraulic

TYPES OF ROD SEALS

Type	Product	Standard Material	Pressure (bar)	Temp. (°C)	Surface speed (m/sec)	Application
Cs33		NBR / PU	16	-30°C + 100°C	1	Pneumatic
Cs34		NBR / Feblic POM	315	-30°C + 120°C	0,5	Hydraulic

WIPER SEALS

Wiper seals (also known as scrapers, excluders or dust seals) to prevent from dirt, dust and foreign contaminants. wiper seals (also known as scrapers, excluders or dust seals) to prevent from dirt, dust and foreign contaminants.









Material	PU
Color	Blue, Green
Shape	Circular
Temperature Range	-22 to 212 deg F

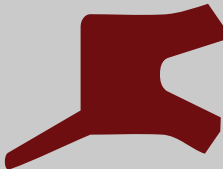

TYPES OF WIPER SEALS

CA1		PU	-	-30 to 105	4	Hydraulic Pneumatic
		NBR		-25 to 100		

TYPES OF WIPER SEALS

Type	Product	Standard Material	Pressure (bar)	Temp. (°C)	Surface speed (m/sec)	Application
CA2		PU	-	-30 to 100	4	Hydraulic Pneumatic
		NBR		-25 to 100		
Ca3		PU / POM*	-	-30 to 100	4	Hydraulic
		NBR / POM*		-25 to 100		
Ca4		PU	-	-30 to 100	4	Hydraulic
		NBR		-25 to 100		
Ca8		PU	-	-30 to 100	4	Hydraulic Pneumatic
		NBR		-25 to 250		
Ca11		PU	-	-30 to 250	4	Hydraulic Pneumatic
		NBR		-25 to 250		
Ca15		PTFE / NBR	-	-45°C + 200°C	15 M/S	Hydraulic
		PTFE / FPM				

TYPES OF WIPER SEALS

Type	Product	Standard Material	Pressure (bar)	Temp. (°C)	Surface speed (m/sec)	Application
Ca16		-	-	-30°C + 110°C	1 M/S	Hydraulic
Ca17		-	-	-30°C + 110°C	1 M/S	Hydraulic

GUIDE RING

Being quality-centric firm, we are engaged in presenting a high-class range of **Guide Ring**.





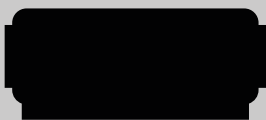

Material	Acetal
Size	160 x 165 x 19.8 mm
Shape	Round
Packing type	Box



TYPES OF GUIDE RINGS



Type	Product	Standard Material	Pressure (bar)	Temp. (°C)	Surface speed (m/sec)
Cf1		POM	-	-60 to 100	4
		PTFE		-200 to 260	
		Polyester Fabric		-40 to 130	

TYPES OF GUIDE RINGS

Type	Product	Standard Material	Pressure (bar)	Temp. (°C)	Surface speed (m/sec)
Cf2		POM	-	-60 to 100	4
		PTFE		-200 to 260	
Cf3		POM	-	-60 to 100	4
		PTFE		-200 to 260	
Cf4		POM	-	-60 to 100	4
		PTFE		-200 to 260	
Cf5		POM	-	-60 to 100	4
		PTFE		-200 to 260	
Cf6		POM	-	-60 to 100	4
		PTFE		-200 to 260	
Cf7		POM	-	-60 to 100	4
		PTFE		-200 to 260	



TYPES OF GUIDE RINGS

Type	Product	Standard Material	Pressure (bar)	Temp. (°C)	Surface speed (m/sec)
Cf8		POM	-	-60 to 100	4
		PTFE		-200 to 260	
Cf9		POM	-	-55 + 120	3
Cf10		Polyester Febric	-	-40 to 130	4

O RING

With a wide range of sizes including standard as well as non standard Crown supplies **O rings** in any elastomeric material as per customer specification

Material	Rubber, Silicone, VMQ
Color	Black & Other
Brand	BK O Ring
Product	O-Ring



TYPES OF O RINGS

NBR O RING

We are one of the prominent Manufacturers of Rubber Wristband, O Rings, Rubber Keychain, Rubber Gasket, Rubber Labels, etc. Offered products are highly demanded across the market for their unmatched quality, good strength and supreme finish.



Material	NBR
Shape	Round
Brand	WD
Product	NBR O-Ring



VITON - O RINGS

Viton-o rings have excellent chemical resistance and can be used at temperature range of between 15°C and 200°C. Although generally more expensive than NBR (Nitrile) O-rings, FKM has found wide acceptance in the aircraft, automotive and chemical industries.

Material	Rubber
Shape	Round
Color	Black
Packing Type	Packet

BACKUP RINGS

Back-up rings are plastic or rubber rings used to prevent the O-ring from entering the clearance gap. When high pressures are exerted on the O-ring, its soft rubber material can be forced into the clearance gap causing the O-ring to extrude.



Material	EPDM
Shape	Round
Color	White
Packing Type	Packet

TYPES OF O RINGS

X RINGS

X-Rings, also known as Quad-Rings, can be used in a wide variety of static and dynamic sealing applications. With the unique 4-lobe configuration, X-rings have 2 sealing areas per side as opposed to 1 sealing area on an O-ring.



Minimum Order Quantity	500 Unit
------------------------	----------



O RINGS BOXES

We provide a solution to the variegated demand of **O Ring Boxes** in the market by manufacturing, trading, importing and supplying the same. The selection is based on chemical compatibility, service temperature, sealing pressure, lubrication requirements and working atmosphere.

Color	Yellow
Shape	Round
Size	725000 mm
Packing Type	Box

O RINGS CORD

Rubber Cord Natural rubber has been deployed to make our rubber cord as sheathing material and cable insulation long ago different insulation, for example, PE and PVC can to be normally used.







Material	Non-Porous Rubber
Size	Any
Brand	Victor

BACKUP RING



We have achieved paramount success in manufacturing, exporting, trading and supplying of corona Backups Rings. These are specifically engineered for pneumatic applications, where cylinders and valves are actuated by air. These seals operate in dynamic applications, often at high speeds, generally with rotary or reciprocating motions. In addition, where a standard product type is not suitable, custom solutions can be developed.



TYPES OF BACKUP RINGS

Type	Product	Standard Material	Pressure (bar)	Temp. (°C)	Surface speed (m/sec)
CST8		POM	-	-60 to 100	4
		PTFE		-200 to 260	
		Polyester Fabric		-40 to 130	
CST9		POM	-	-60 to 100	4
		PTFE		-200 to 260	
CST10		POM	-	-60 to 100	4
		PTFE		-200 to 260	
CST11		POM	-	-60 to 100	4
		PTFE		-200 to 260	

TYPES OF BACKUP RINGS

Type	Product	Standard Material	Pressure (bar)	Temp. (°C)	Surface speed (m/sec)
CST 12		POM	-	-60 to 100	4
		PTFE		-200 to 260	
CST 13		POM	-	-60 to 100	4
		PTFE		-200 to 260	

PNEUMATIC SEALS

We are a trustworthy organization offering a wide a gamut of **Pneumatic Seal**.

Material	PU
Min Temperature	-40 deg c
Max Temperature	120 deg c



OIL SEALS



OIL SEALS

We are supplying a wide range of **Oil Seals** that are used to stop the fluid from leaking out between the shaft and housing. The seal is also used to prevent materials such as dust, dirt, and derbies from moving in through the clearance.

Material	Metal Rubber
Style	Mechanical Seal, Hydraulic, Floating
Product Type	Oil
Packing Type	Standard

TYPES OF OIL SEALS

OS-1 OIL SEALS

Oil Seals are other superb quality products which our company is providing to its clients at a very convenient range of prices. We are one of the most renowned and well known companies which are extensively engaged in the trader, wholesaler and exporter of several kinds of supreme quality Components in the market.

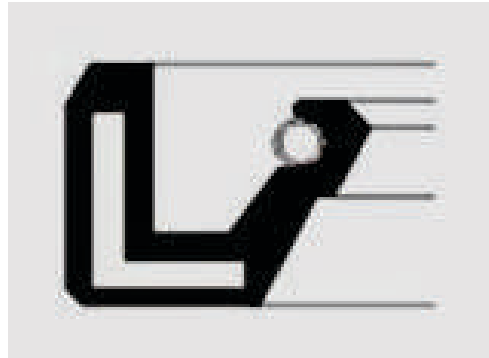

Size	As Per Requirement
------	--------------------

OS-2 OIL SEALS

The OS-2 type is metal outside but - open type oil seal. The metal encased on the outer diameter and on the non fluid sealing side ensures a better resistance to thermal expansion when compared to rubber cased metal oil seals or rubber oil seals.



Size	As Per Requirement
------	--------------------

OS-3 OIL SEALS

The OS-3 type is a closed type covered with both side metal oil, the complete metal encased ensure strength for seal. Specially for heavy application.

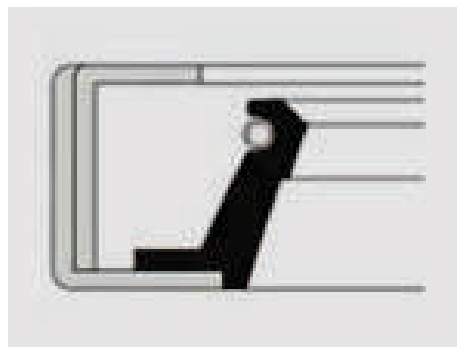

Size	As Per Requirement
------	--------------------

OS-4 OIL SEALS

OS-4 is similar to OS1 type rotary shaft seal but with an additional dust lip which is provided to avoid entry of light to medium dust and dirt.

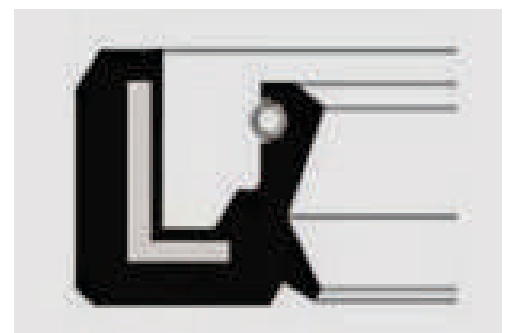

Size	As Per Requirement
------	--------------------

TYPES OF OIL SEALS

OS-5 OIL SEALS

OS-5 is similar to OS2 type rotary shaft seal but with an additional dust lip which is provided to avoid entry of light to medium dust and dirt.

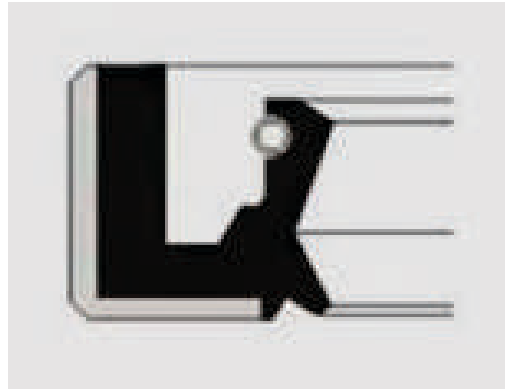

Size	As Per Requirement
------	--------------------

OS-6 OIL SEALS

OS-6 is similar to OS3 type rotary shaft seal but with an additional dust lip which is provided to avoid entry of light to medium dust and dirt.

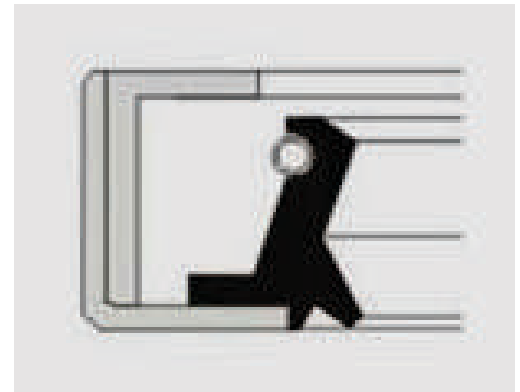

Size	As Per Requirement
------	--------------------

OS-7 OIL SEALS

The OS-7 rotary shaft seal is useful where pressure is in excess of 0.5 bar or for seal with small diameter where spring cannot be loaded.



Size	As Per Requirement
------	--------------------

OS-8 OIL SEALS

The OS-8 rotary shaft seal is similar to the OS1 but has an advantage of better housing retention.

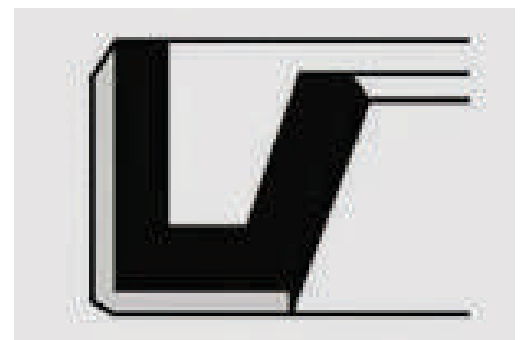

Size	As Per Requirement
------	--------------------



TYPES OF OIL SEALS

OS-9 OIL SEALS

The OS-9 rotary shaft seal can be used for sealing two separate fluids. e.g. coolant from shaft side to enter the bearing or to avoid the leakage of bearing lubricant from the



Size	As Per Requirement
------	--------------------

OS-10 OIL SEALS

OS-10 is heavy duty oil seal where the friction is more than normal, specially for heavy vehicles axles.



Size	As Per Requirement
------	--------------------

OS-11 OIL SEALS

OS-11 is similar to OS-10 but with additional dual till to prevent dust from other side.



Size	As Per Requirement
------	--------------------

FABRIC OIL SEALS

We offer our clients with various fabric oil seals at highly competitive prices. These are available in various different profiles for major applications such as high performing vehicles, conveyor rollers, electric motors and vacuum pumps. Our fabric oil seals can be provided to the clients in customized sizes and specifications as per the client's requirements.



TYPES OF FABRIC OIL SEALS

FOS - 1

The FOS-1 types of shaft seals are used wherever additional lubrication is not necessary. In case lubrication is required, seals are installed back to back with a lubrication metal

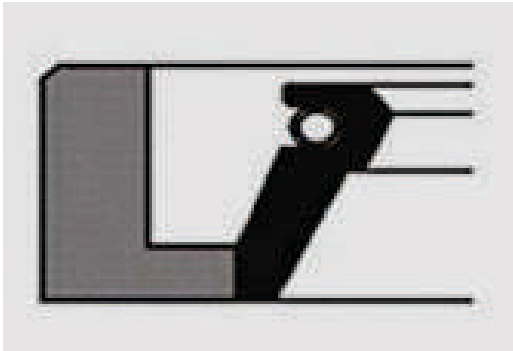

FOS - 2

The FOS-2 seal is especially recommended for ensuring longer seal life. But in this case, the housing has to be provided with a lubricating groove port.

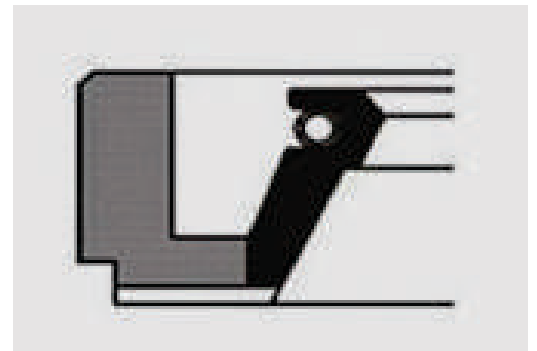

FOS - 3

The FOS-3 seal is similar to the FOS-1 type seal with additional slots provided on the back face of the seal to enable additional area for lubricating the sealing lip, thus preventing dry running or damage to the sealing lip.

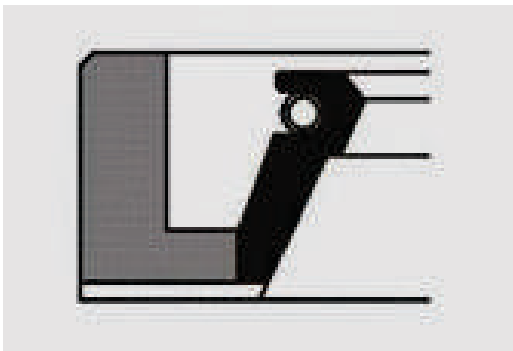

FOS - 4

The FOS-4 seal is especially recommended for ensuring longer seal life. But in this case, the housing has to be provided with a lubricating groove port.

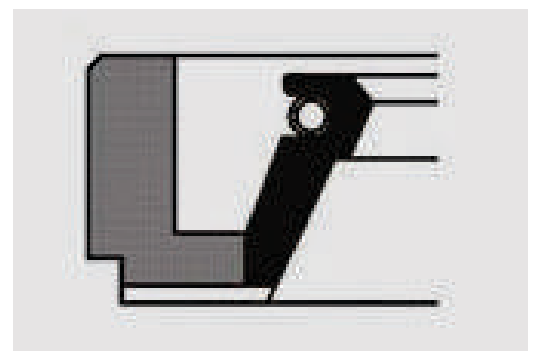

V RINGS

V RINGS

The Forsheda type Rubber Seals is an all-rubber seal that seats directly on the shaft and seals axially against a counterface, housing, seal case or similar surface.



Color	Black
Material	FKM Viton Nitrile Rubber
Brand	Dataseal

TYPES OF V RINGS

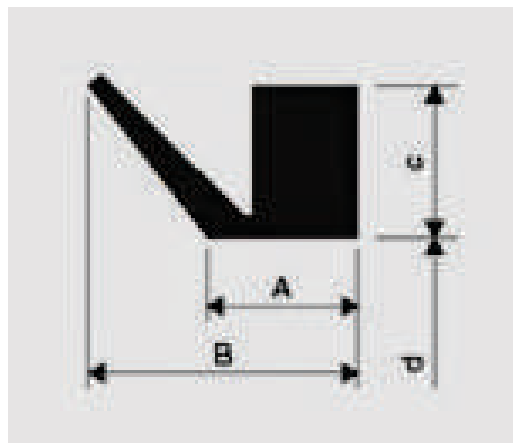

CVA

V rings is fixed on the shafts, they seal axially against a perpendicular counter face, whether it is the housing it self for a bearing outer surface. They can be utilised as either a primary or backup seal and do an excellent job as a slinger of foreign materials, specially at higher states.

CVS

V rings is fixed on the shafts, they seal axially against a perpendicular counter face, whether it is the housing it self for a bearing outer surface. They can be utilised as either a primary or backup seal and do an excellent job as a slinger of foreign materials, specially at higher states.

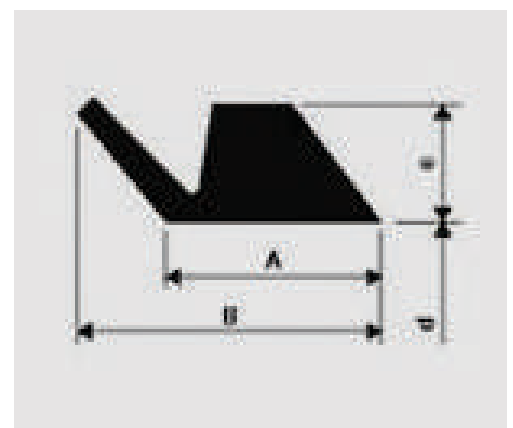

TYPES OF V RINGS

CVL

V rings is fixed on the shafts, they seal axially against a perpendicular counter face, whether it is the housing it self for a bearing outer surface. They can be utilised as either a primary or backup seal and do an excellent job as a slinger of foreign materials, specially at higher states.

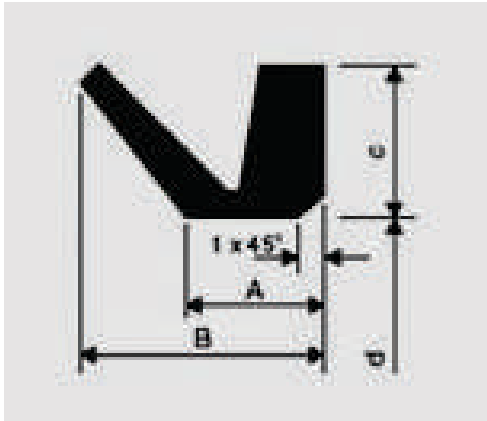

CVE

V rings is fixed on the shafts, they seal axially against a perpendicular counter face, whether it is the housing it self for a bearing outer surface. They can be utilised as either a primary or backup seal and do an excellent job as a slinger of foreign materials, specially at higher states.

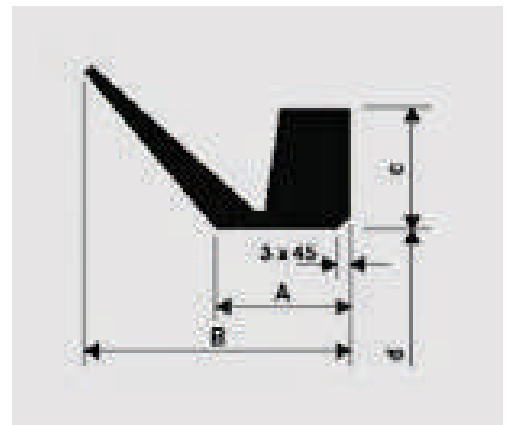

POLYURETHANE PRODUCT

PU BLOCKS

Ranked amongst the foremost companies of this domain, we are readily engaged in offering a superb quality gamut of **PU Block** at reasonable rates.



Size	As Per Client Requirement
Color	Multicolor
Usage	Industrial

PU BUSHES

We are a coveted manufacturer and supplier of optimum quality **PU Bush** that finds application in automobile industry. Proposed bush is design and manufactured under the guidance of our skilled panel of professionals using quality-tested polyurethane polymers and advanced engineering methodology



Shape	Round
Inner Diameter	5 - 10
Outer Diameter	10 - 20
Packaging Type	Box
Material Grade	25 - 50 kg

PU COUPLINGS



To cater the emerging demands of our prestigious customers, we are providing a comprehensive range of **PU couplings**. The offered PU Spiders are available in variety of customized specifications by us and are checked on different quality parameters to confirm its adherence with the laid norms and industry standards.

Minimum Order Quantity	20 Pieces
------------------------	-----------

PU DAMPING PADS

We take pleasure to introduce ourselves as one of the renowned firms for providing the best-in-class range of **PU Damping Pads**.



Material	Polyurethane
Brand	Sarthak
Shape	Rectangular
Hardness	20 to 80 shore A



PU MINING SCREENS

We deal in a wide variety of this product , please contact us for the best quality and the prices.



Material	Good
Size	All
Brand	K K PU



HYDROCYCLONE

A hydrocyclone is a high-throughput gravity separation device used for separating slurry particles based on particle weight, it comes in Polyurethane and other material.

PU PADS

We are a prominent manufacturer and supplier of an exclusive range of **PU Pads**. The offered range is fabricated utilizing high grade factor inputs and advanced technology by our skilled professionals to meet the set international quality standards.



Color	Red, Green, Yellow, Black, White
Material	PU
Brand	PU Polymers
Shape	Square





PU RODS

In order to meet various demands of our esteemed clients, we are engaged in manufacturing and trading an optimum quality array of **PU Rod**.

Color	Yellow
Material	PU
Compression	25 to 30%
Length Available	12 to 300mm



PU ROLLERS

Our firm is proficient to offer **PU Rollers** in various sizes and designs. Professionals make these products by using advanced technique and finest grade raw material that is obtained from trustworthy retailers of market.

Model No/Name	PU 200
Material	PU
Brand	Jek min
Shape	Any
Product Type	Drilling, Industrial Roller
Color	Red



PU SCRAPERS

PU scrapers will keep your belt safe and increase its life along with the production in your plant.

Color	Red
Material	PU
Brand	JR Industries

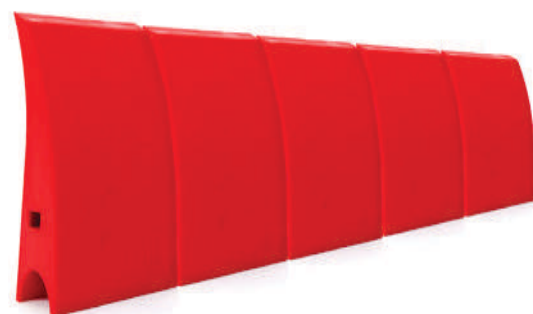

PU SEALS

Pu seal used for industrial use in hydraulic machines any size any model are available

Material	PU
Usage/Application	Industrial
Size	Any
Brand	All
Color	All



PU SHEETS

We deal in high quality of products which are available on customer demand at affordable prices.

Thickness	2mm
Color	Yellow
Feature	Printed
Material	PU
Type	Sheet

PU SLEEVES

New product in Market, works by hydraulic principle. Diameter of 24 inches and length of 72 inches. High demand for steel coil application.

Brand	Sriram Foam
Diameter	24 Inches
Length	72 Inches
Finish	Matte
Surface	Coated
Material	PU



MUD PUMP SEALS

Mud pumps are essential equipment for any oil or gas well. They are used to move drilling mud and other fluids needed during the drilling process and seals are the heart of pump, its comes with various type of material like Polyurethane, Rubber, Cast iron etc.



PU WHEELS

we have polyurethane wheels in veriouscolour ie. Yellow / Red / Orange

Material	Polyurethane
Brand	Prinax
Core Type	Cast Iron
Shape	Round
Size	0 - 600 mm
Diameter	600 mm
Density	1.12 - 1.25g/cm3

MOLDED RUBBER PARTS

With our in-depth knowledge and experience of this industry, we are engaged in providing exceptional quality range of **Molded Rubber Parts** of the following specifications.

Color	Black
Size	Customized
Material	Natural Rubber
Hardness	50 / 60



CUSTOM MOLDED RUBBER PARTS

RUBBER MOULDINGS

We are known for offering Rubber Mouldings that are immensely used in fly wheel magnetos. The copper winding on the bobbins is done. For these moldings, we use single inserts, multiple inserts and also lamination packs.



Type of Rubber Molding	Compression Molding
Raw Material Procurement	Service Provider End

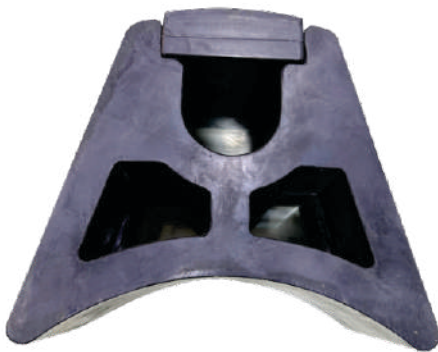

RUBBER PIPE SADDLES

Rubber saddle is a support consisting of a stanchion that utilizes a curved section for cradling the pipe, its comes in various material like NBR, EPDM, Polyurethane etc.

DIFFUSER PLATES

Flow centrifugal pump is the diffuser pump, in which, after the fluid has left the impeller, it is passed through a ring of fixed vanes that diffuse the liquid, providing a more controlled flow and a more efficient conversion of velocity head into pressure head.



RUBBER DIAPHRAGM

Over the years we have been engaged in offering world class Rubber Diaphragm to our clients. These are manufactured using latest tools and techniques under the strict surveillance of our experts.



Color	Black
Material	Rubber
Thickness	4 - 16
Shape	Round
Minimum Order Quantity	10 Piece

RUBBER GASKETS

We hold expertise in offering **Rubber Gaskets**, which is procured from authentic vendors of the market. These rubber gaskets prevents gas leakage and thus are widely used in various engineering and automobile industries.



Brand	Laxmi Rubber
Shape	Flat Gasket
Material	Natural
Packaging Type	Round
Color	Black, Blue, Orange Etc
Hardness	40 - 90 Shore A

TEFLON & PLASTIC PRODUCTS

We are recognized as a successful manufacturers, traders, exporters and suppliers of **Teflon & Plastic Products**. These products from our end are provided using superior quality materials and are made available at industry leading rates. These are amazing on the performance front and are provided to the customers in customized packaging and as per the set industry norms and guidelines.



TEFLON AND NYLON

Our company is concerned with presenting an extensive array of **Teflon And Nylon Rod**, which is made accessible from us in diverse stipulations. Due to the smooth finishing, sturdy construction and corrosion resistance, the provided array is extremely demanding and recognized among customers. Teflon and nylon rods are developed by our vendors' professionals in harmony with the predefined global standards.



TYPES OF TEFLON AND NYLON PRODUCTS

RUBBER GASKETS

We hold expertise in offering **Rubber Gaskets**, which is procured from authentic vendors of the market. These rubber gaskets prevents gas leakage and thus are widely used in various engineering and automobile industries.

Brand	Laxmi Rubber
Shape	Flat Gasket
Material	Natural
Packaging Type	Round
Color	Black, Blue, Orange Etc
Hardness	40 - 90 Shore A

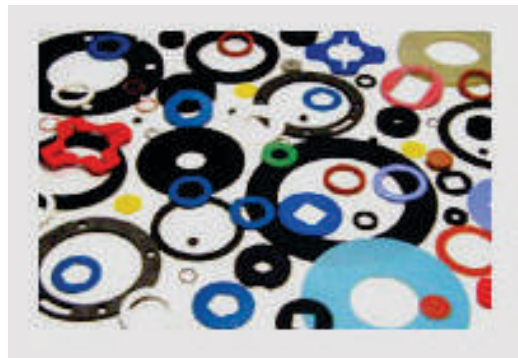

TEFLON & PLASTIC PRODUCTS

We are recognized as a successful manufacturers, traders, exporters and suppliers of **Teflon & Plastic Products**. These products from our end are provided using superior quality materials and are made available at industry leading rates.

Material	Plastic
Color	Silver
Packaging Size	Standard





CROWN RUBBER WORKS

Manufacturing of
Oil Seals, Hydraulic &
Pneumatic Seals
& all types of Rubber
& PU Products.

TOTAL SEALING SOLUTIONS

Address : W-10, TTC Industrial Area,
Pawane MIDC, Behind GAMI
Industrial Estate,
Navi Mumbai - 400705.

GST No. : 27AACPA2514M1Z1

Office No. : +91 9321114471
+91 7738114471

Email : enquiry@crownrubber.in
anis@crownrubber.in

Website : www.crown-rubber.com

Google Map : <https://goo.gl/maps/FMQBXZNPfuS2>